

S-5![®]

The Right Way!

S-5![®] Utility System

The new S-5![®] Utility System is the most versatile utility mounting solution for standing seam metal roofs, and is exclusively from S-5!

The Utility System enables easy attachment of almost any conceivable utility application, including: signs, banners, light fixtures, gas piping, antennas, roof walkways, HVAC equipment, lightning protection systems, condensate lines, stack/flue bracing, fascias, equipment screens, electrical conduit, antennas, cabling, and more.

The Utility System utilizes round-point setscrews to ensure a non-penetrating attachment. The setscrews will slightly dimple the metal seam material without piercing it, leaving roof manufacturers' warranties intact.

All included hardware is stainless steel. Please visit www.S-5.com for more information including CAD details, metallurgical compatibilities and specifications. The S-5! Utility System has been tested for load-to-failure results on most major brands and profiles of standing seam roofing.

S-5! mini clamps are not compatible with, and should not be used with S-5! SnoRail™/SnoFence™ or ColorGard® snow retention systems.



The Utility System is the most versatile utility mounting solution on the market.

S-5![®] Utility System



888-825-3432 | www.S-5.com

The right way to attach almost anything to metal roofs!



Attach almost any conceivable utility application, including: signs, banners, light fixtures, gas piping, antennas, roof walkways, HVAC equipment, lightning protection systems, condensate lines, stack/flue bracing, fascias, equipment screens, electrical conduit, antennas, cabling, and more.

Utility System Components

(sold separately)

Flanged Mini Clamps

With a selection of three uniquely designed flanged mini clamps, the Utility System can be mounted to every major standing seam metal roof profile. The S-5-USF Mini fits 85% of U.S. standing seam profiles including most snap together and machine folded seams. The S-5-EF Mini is specifically for double-fold standing seams, while the S-5-ZF Mini fits bulb-shaped profiles.

Clamp installation is simple. Just place the flanged mini clamp on the seam and tighten the round-point setscrew. Go to www.S-5.com/tools for information about properly attaching S-5!® clamps.

S-5-FA

If the metal roof profile isn't compatible with the three flanged mini clamps mentioned above, the Utility System can utilize the S-5-FA to quickly provide a flanged component to any of the other S-5! mini clamps, such as the S-5-N Mini for 1" nail-strip profiles, the S-5-T Mini for T-shaped profiles, the S-5-Q Mini for large bulb-shaped profiles, and S-5-K Grip Mini for bulb snap-together profiles.

Dual Grip Strut

The Dual Grip Strut* conveniently comes in 3.00" and 27.00" lengths, enabling a wide variety of attachment needs. Custom lengths are also available. It can be easily rotated 360° on the mini clamps for orientation versatility only S-5! can provide!

*Not for use with solar rails.

S-5-USF Mini

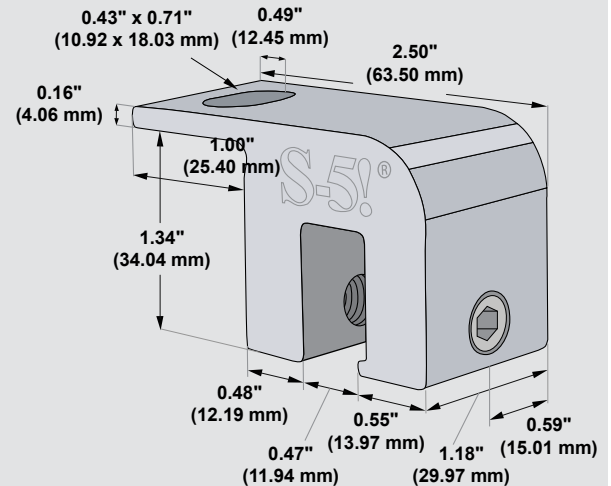

S-5-FA

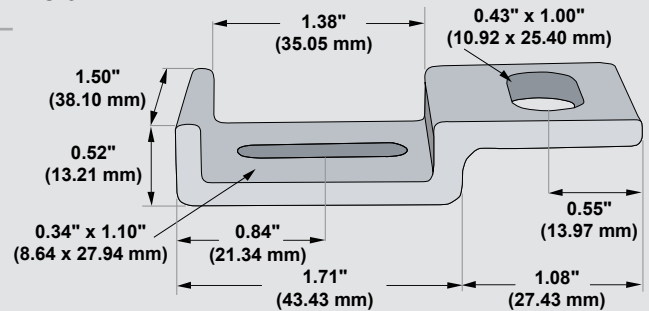

Dual Grip Strut

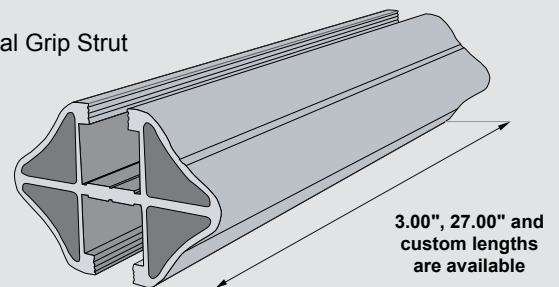

Additional Clamp Options

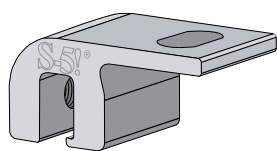

S-5-EF Mini

Visit www.S-5.com for dimensions.

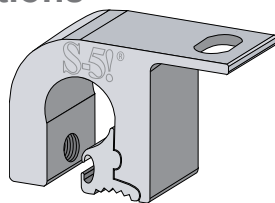

S-5-ZF Mini

Example Applications

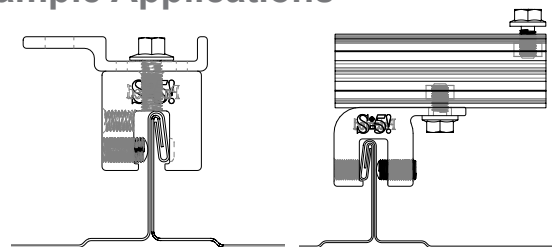

S-5!® Warning! Please use this product responsibly!

Products are protected by multiple U.S. and foreign patents. Visit the website at www.S-5.com for complete information on patents and trademarks. For maximum holding strength, setscrews should be tensioned and re-tensioned as the seam material compresses. Clamp setscrew tension should be verified using a calibrated torque wrench between 160 and 180 inch pounds when used on 22ga steel, and between 130 and 150 inch pounds for all other metals and thinner gauges of steel. Consult the S-5! website at www.S-5.com for published data regarding holding strength.

Copyright 2015, Metal Roof Innovations, Ltd. S-5! products are patent protected. S-5! aggressively protects its patents, trademarks, and copyrights. Version 052115.

Distributed by